

## TECHNICAL DATA

MODEL	MV-A & MV-AS Brass Material MV-B & MV-BS Stainless Steel Material MV-E is with Aluminium Bronze Material	
TYPE	MV-A, MV-B & MV-E are without strainer MV-AS & MV-BS are with strainer	
MAXIMUM WORKING PRESSURE	12 Bar (175 PSI)	
EFFECTIVE WORKING PRESSURE	1.4 to 3.5 Kg/Sq.cm (20 - 50 PSI)	
END CONNECTION	1/2" BSPT (1/2" NPT OPTIONAL)	
MATERIAL	Refer Table-I	
INCLUDED WATER SPRAY ANGLE FOR EACH K-FACTOR	140°, 120°, 110°, 100°, 90°, 80° & 65°	
K FACTOR	MV-A/MV-B & MV-E	MV-AS/MV-BS
	Metric (US)	Metric (US)
	K-18 (1.26)	K-18 (1.26)
	K-22 (1.54)	K-22 (1.54)
	K-30 (2.10)	K-30 (2.10)
	K-35 (2.45)	K-35 (2.45)
	K-41 (2.87)	K-41 (2.87)
	K-51 (3.57)	
	K-64 (4.48)	
	K-79 (5.53)	
	K-91 (6.37)	
	K-102 (7.14)	
WEIGHT (Approx)	0.110 Kg	
FINISH	MV-A & MV-AS Natural Brass finish. Chrome plated Nickel, Electroless Nickel plated, Epoxy powder coated. MV-B, MV-BS & MV-E Natural finish	
APPROVALS	Nozzle - UL Listed & FM Approved Blow-off Plug - FM Approved	
ORDERING INFORMATION	Specify K-Factor, spray angle, finish, model and end connection	



## DESCRIPTION

The HD® Medium Velocity Water Spray Nozzles are open type (non-automatic nozzles, designed for directional spray application in fixed fire protection system.

Medium velocity water spray nozzle has an external deflector, which discharges water in a directional cone shaped pattern of small droplet size. The water is uniformly distributed over the surface to be protected.

The Nozzles are effectively designed to apply water to exposed vertical, horizontal, curved and irregular shaped surfaces to allow cooling to prevent excessive absorption of heat from external fire and avoid structural damage or spread of fire. In some application nozzles may be installed to control or extinguish the fire depending on water design density as per applicable codes. The nozzle is used in deluge water spray system for special hazard fire protection application.

As the design and intent of specific water spray system may vary considerably, MV nozzle is made available in several combinations of orifice sizes and spray angles.

The minimum desirable pressure to achieve a reasonable spray pattern is 1.4 Kg./Sq.cm. The water distribution pattern as shown in the graph in following pages is at an average pressure of 2.0 Kg/Sq.cm. The change in pressure between 1.4 to 3.5 Kg./sq.cm. does not affect considerable change in spray angle.

The spray pattern shown is with indoor application. System designer must consider wind velocity while designing the system for outdoor application. Field obstruction if any affecting the spray pattern of the nozzle must also be considered. The nozzle may be oriented to any position as deemed necessary to cover the hazard.

The Blow-off plugs can be used to prevent the depositing of foreign materials in the water way of the nozzles, which could interfere with discharge of the spray nozzle. Blow-off plugs are optional and are FM Approved. Blow-off Plugs have identification mark with respect to K factor. Blow off plug for nozzle having K-factor 22 will have identification mark of 22. Minimum operating pressure for nozzle having Blow-off plug is 1.4 Kg./Sq.cm (20 PSI).

The main pipeline strainer as per NFPA-15 is required for system utilizing nozzle orifice diameter less than 9.5mm (3/8 inch), i.e.MV Nozzle having K-factor 51 and less, and also for the system water likely to contain obstructive materials.

## INSTALLATION & MAINTENANCE

The spray nozzle must be handled with due care. For best results, the storage as well as any further shipment be made in original packing only.

Nozzle which is visibly damaged should not be installed. Use Teflon tape or soft thread sealant on male thread of the nozzle.

The nozzles must be hand tightened into the fitting. After hand tightening use Nozzle Wrench-NW-M for wrench tightening in to nozzle fittings. Excessive tightening torque may result into serious damage to nozzle arms and the deflector, which may affect spray pattern of the nozzle and its performance.

It is recommended that water spray system be inspected regularly by authorised technical personnel.

The nozzle must be checked for atmospheric effects, external and internal obstruction, blockage if any. The system must be operated with optimum water flow at least twice in a year or as per the provisions of NFPA /TAC or local authority having jurisdiction.

The owner is solely responsible for maintaining the water spray system and the components there in so that it performs properly when required.

### MODEL MV-A, MV-B & MV-E

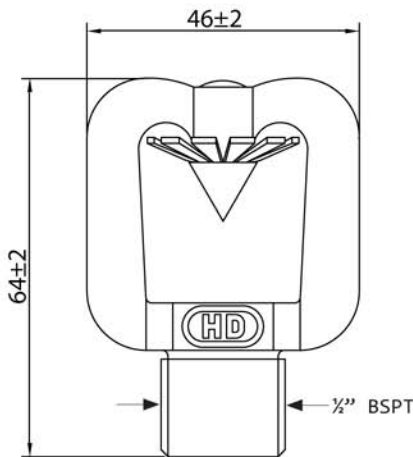

### MODEL MV-AS, & MV-BS

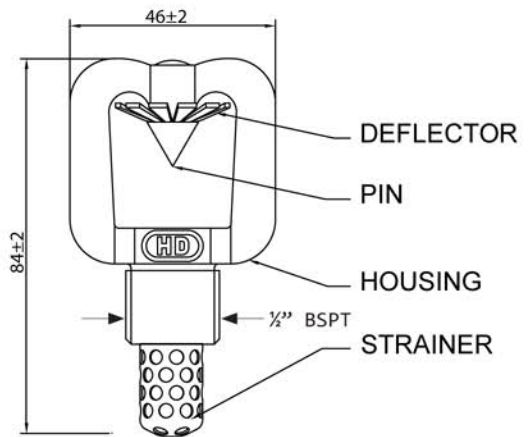

### Nozzles with Blow-off Plug

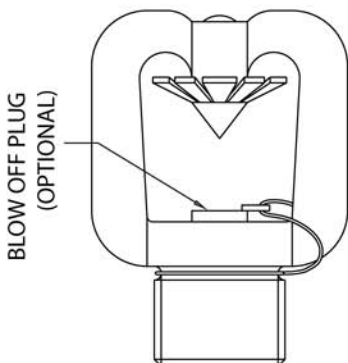
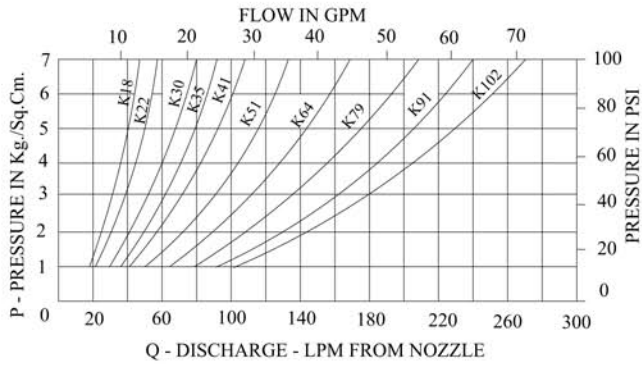

TABLE - I : MATERIAL OF CONSTRUCTION

COMPONENT	MODEL MV-A & MV-AS	MODEL MV-B & MV-BS	MODEL MV-E
HOUSING	BRASS, IS:291 GR. -1 (EQUIVALENT TO ASTM B21)	A351-CF8M	Aluminium Bronze IS:305-AB1 (Equivalent to ASTM-A148)
PIN	BRASS IS:291. GR. -1 (EQUIVALENT TO ASTM B21)	ASTM-A479 GR 31803	Ph.Bronze IS:7811 (Equivalent to B139/BS2874-PB102)
DEFLECTOR	BRASS IS:2768 (EQUIVALENT TO ASTM B36)	ASTM A240 GR 2205	Ph.Bronze IS:7814-GR-II (Equivalent to BS2870-PB102)
STRAINER	COPPER (FOR MV-AS)	STAINLESS STEEL 316 FOR (MV-BS)	-
BLOW-OFF CAP	ELASTOMER	ELASTOMER	ELASTOMER

## DISCHARGE CHARACTERISTICS



$Q = K \sqrt{P}$  where P is supply pressure in Kg/sq.cm., K= nozzle constant (K-factor) in metric  
 US K factor = Metric K factor MK ÷ 14.2745

## SPRAY PATTERN

### SPRAY ANGLE 65°

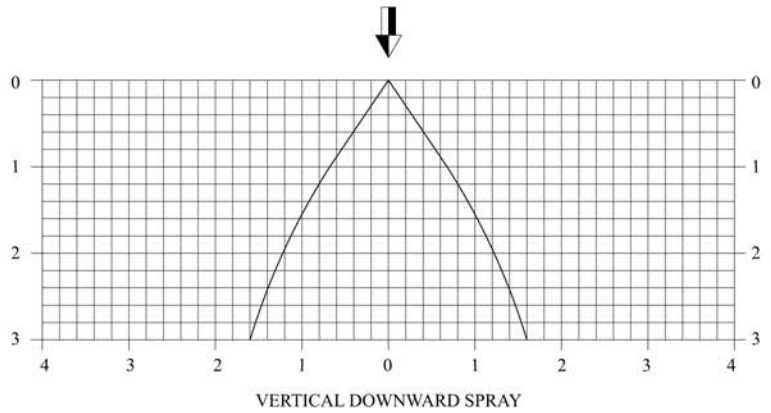
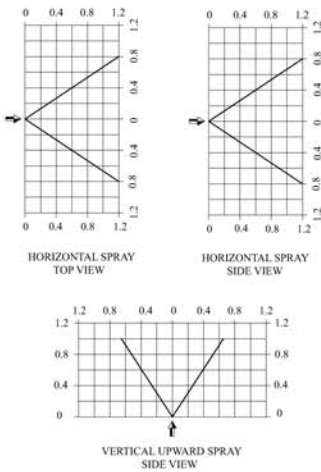

### SPRAY ANGLE 80°

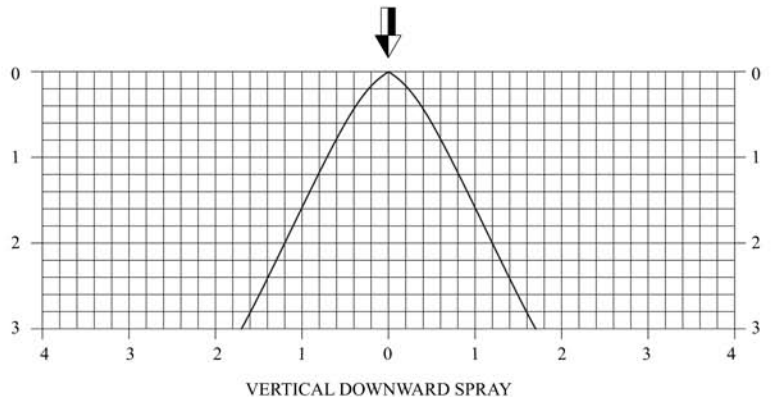
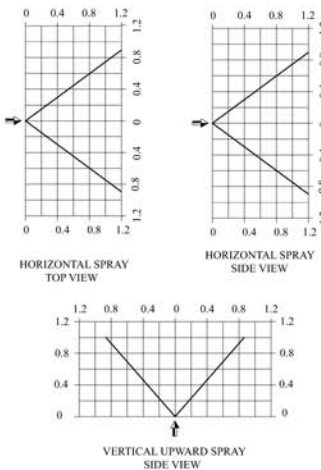

ALL DIMENSIONS ARE IN METERS

# SPRAY PATTERN

## SPRAY ANGLE 90°

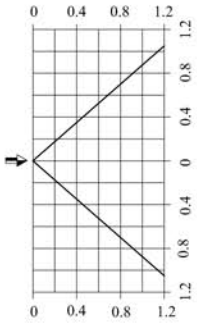

HORIZONTAL SPRAY  
TOP VIEW

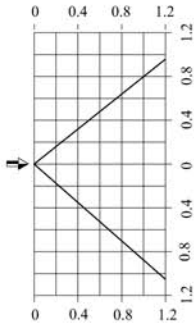

HORIZONTAL SPRAY  
SIDE VIEW

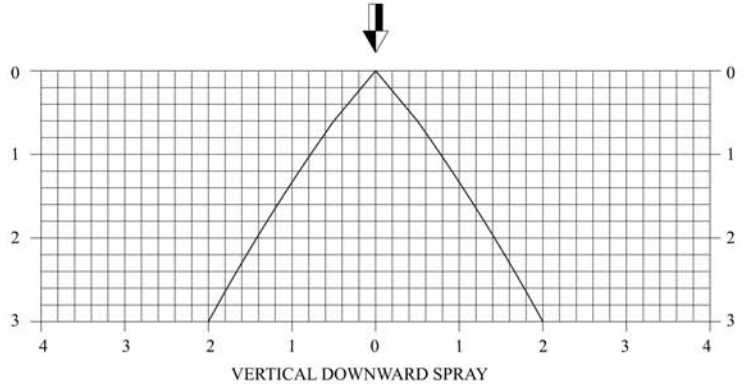

VERTICAL DOWNWARD SPRAY

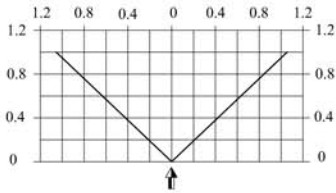

VERTICAL UPWARD SPRAY  
SIDE VIEW

## SPRAY ANGLE 100°

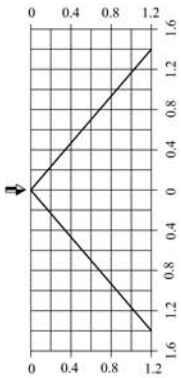

HORIZONTAL SPRAY  
TOP VIEW

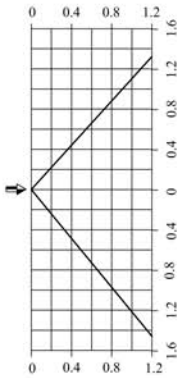

HORIZONTAL SPRAY  
SIDE VIEW

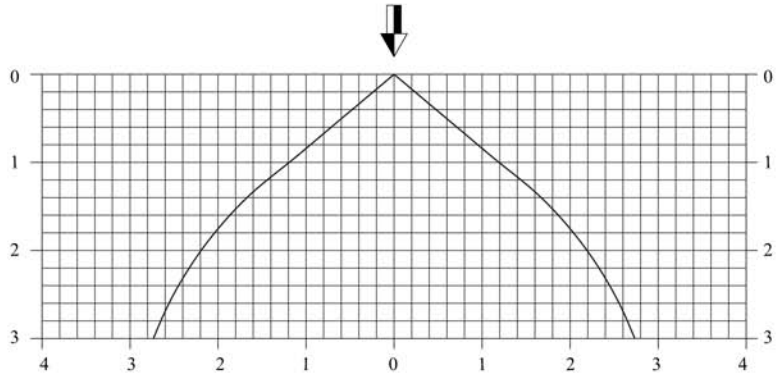

VERTICAL DOWNWARD SPRAY

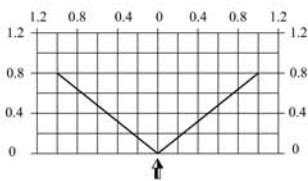

VERTICAL UPWARD SPRAY  
SIDE VIEW

ALL DIMENSIONS ARE IN METERS

# SPRAY PATTERN

## SPRAY ANGLE 110°

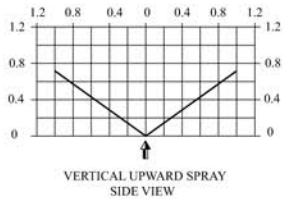
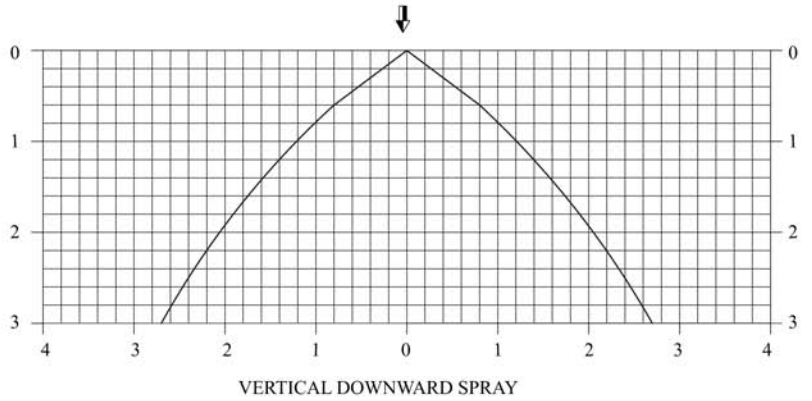
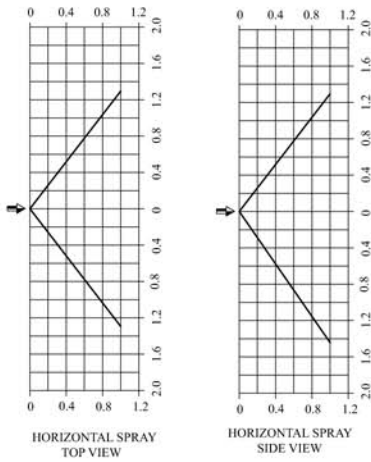

## SPRAY ANGLE 120°

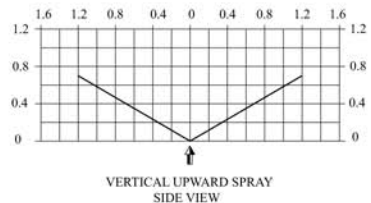
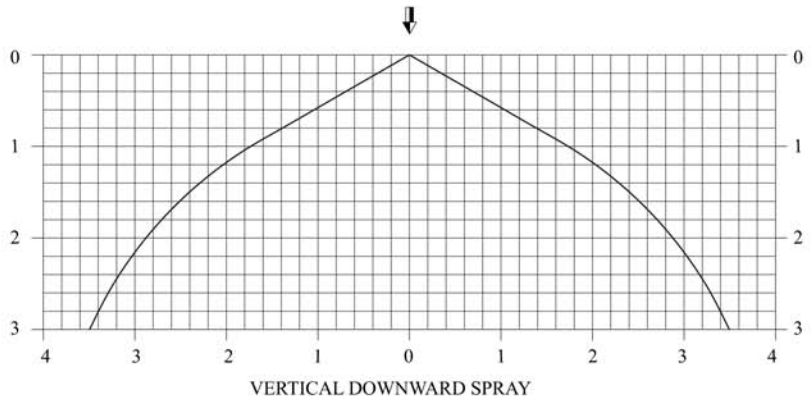
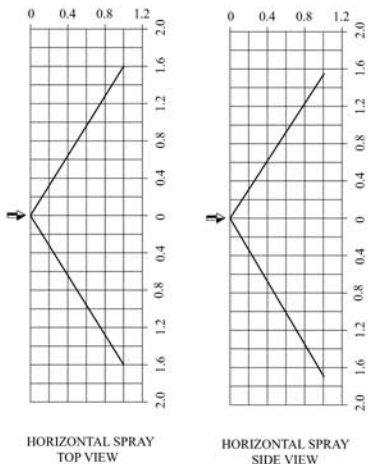

ALL DIMENSIONS ARE IN METERS

## SPRAY PATTERN

### SPRAY ANGLE 140°

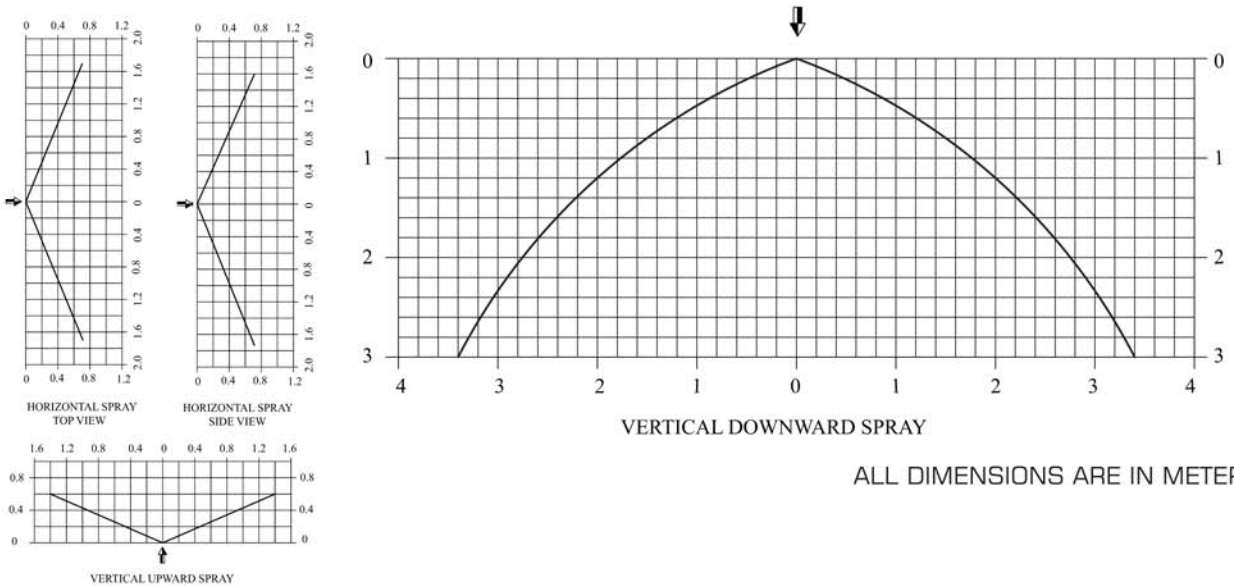

#### Note :

- 1) The design spray pattern given in graph are included spray angle of 65 Deg. to 140 Deg. at nozzle inlet pressure of 1.4 to 3.5 Bar. When the nozzle pressure above 3.5 is applied, the coverage area will decrease because the spray pattern tends to draw inward at higher pressure.
- 2) The spray data are obtained from the test in still air.

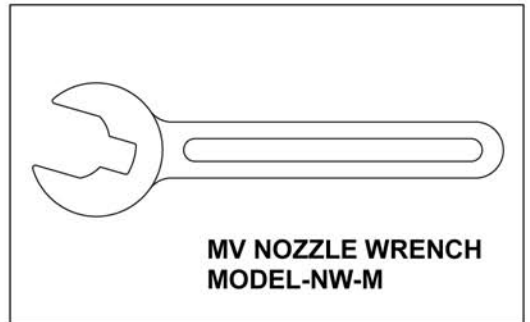

#### LIMITED WARRANTY

HD FIRE PROTECT PVT. LTD. hereby referred to as HD FIRE warrants to the original purchaser of the fire protection products manufactured by HD FIRE and to any other person to whom such equipment is transferred, that such products will be free from defect in material and workmanship under normal use and care, for two (2) years from the date of shipment by HD FIRE. Products or Components supplied or used by HD FIRE, but manufactured by others, are warranted only to the extent of the manufacturer's warranty. No warranty is given for product or components which have been subject to misuse, improper installation, corrosion, unauthorized repair, alteration or un-maintained. HD FIRE shall not be responsible for system design errors or improper installation or inaccurate or incomplete information supplied by buyer or buyer's representatives. HD FIRE will repair or replace defective material free of charge, which is returned to our factory, transportation charge prepaid, provided after our inspection the material is found to have been defective at the time of initial shipment from our works. HD FIRE shall not be liable for any incidental or consequential loss, damage or expense arising directly or indirectly from the use of the product including damages for injury to person, damages to property and penalties resulting from any products and components manufactured by HD FIRE. HD FIRE shall not be liable for any damages or labour charges or expense in making repair or adjustment to the product. HD FIRE shall not be liable for any damages or charges sustained in the adaptation or use of its engineering data & services. In no event shall HD Fire's product liability exceed an amount equal to the sale price. The foregoing warranty is exclusive and in lieu of all other warranties and representation whether expressed, implied, oral or written, including but not limited to, any implied warranties or merchantability or fitness for a particular purpose. All such other warranties and representations are hereby cancelled.

#### NOTICE :

The equipment presented in this bulletin is to be installed in accordance with the latest publication standards of NFPA or other similar organisations and also with the provision of government codes or ordinances wherever applicable. The information provided by us is to the best of our knowledge and belief, and consist of general guidelines only. Site handling and installation control is not in our scope. Hence we give no guarantee for result and take no liability for damages, loss or penalties whatsoever, resulting from our suggestion, information, recommendation or damages due to our product. Product development is a continuous programme of HD FIRE PROTECT PVT. LTD. and hence the right to modify any specification without prior notice is reserved with the company.